

ESH / EWH **ERGOSTYLE MACHINE GUARD HANDLES**



ESH-S **ESH-H**
(Closed Style)



EWH-S **EWH-H**
(Open Style)



Handle	Cover Cap
Glass-fiber reinforced polyamide plastic	Polyester plastic Glossy Finish
Black matte	Black, orange, gray, yellow, light blue or red

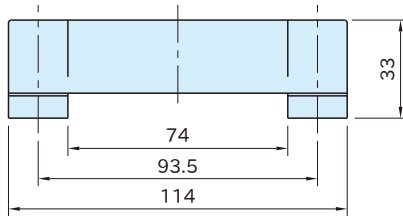
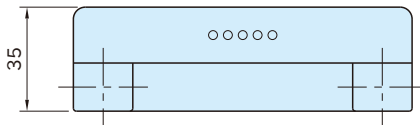

(Closed Style)

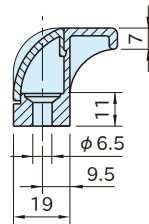

ESH-S
Front Mounting

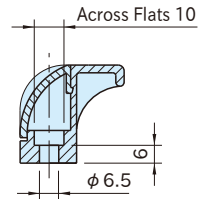

ESH-H
Back Mounting

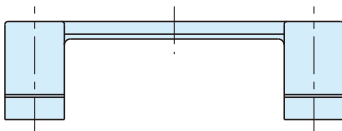
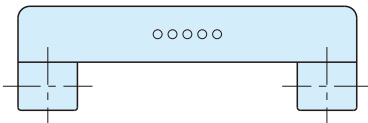

(Open Style)

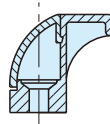

EWH-S
Front Mounting

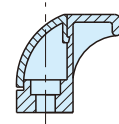

EWH-H
Back Mounting

ESH-S ESH-H (Closed Style)

Part Number		Weight (g)
Countersunk-Head Screw Mounting	Socket-Head Cap Screw Mounting	
ESH110S	ESH110H	33

EWHS EWH-H (Open Style)

Part Number		Weight (g)
Countersunk-Head Screw Mounting	Socket-Head Cap Screw Mounting	
EWHS110S	EWHS110H	26

- The closed style allows protecting operator's fingers.
- Working temperature : Between -30°C and 110°C
- Use in hot or highly humid circumstances can deteriorate the plastic material properties.
- A handle and caps are packed separately and not delivered in assembly.

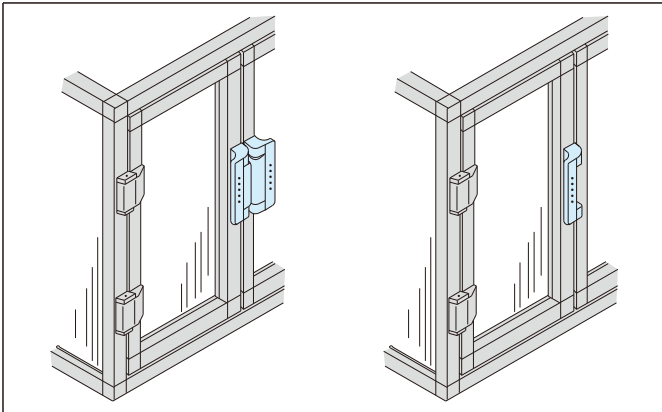
Application Examples

Mounting on single swinging or gatefold doors

Ordering Example
ESH110S - BR

Part Number Color Code

Color Code	Cap Color
OG	Orange
GR	Gray
YE	Yellow
LB	Light Blue
BR	Black
RE	Red

Tensile Stress

Part Number	F_1 [N]
ESH110	90
EWHS110	

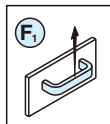
Tensile Stress

·The stated F_1 values denote the average of the breaking loads measured in a breaking test under normal working conditions.

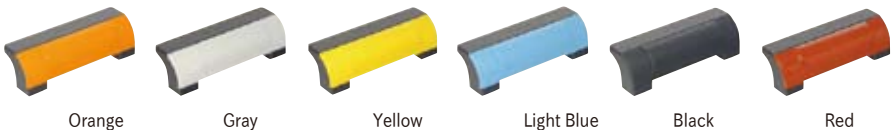

Orange

Gray

Yellow

Light Blue

Black

Red